

# Manganese Dioxide Lithium Coin Batteries: Individual Specifications

## CR1220

### ■ Dimensions(mm)

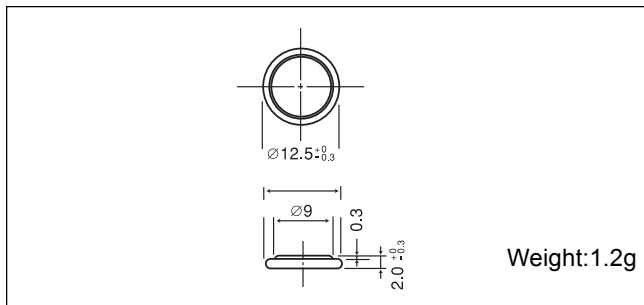

### ■ Specification

Nominal voltage (V)	3
Nominal capacity (mAh)	35
Continuous standard load (mA)	0.1
Operating temperature (C)	-30 ~ +60

### ■ Temperature Characteristics

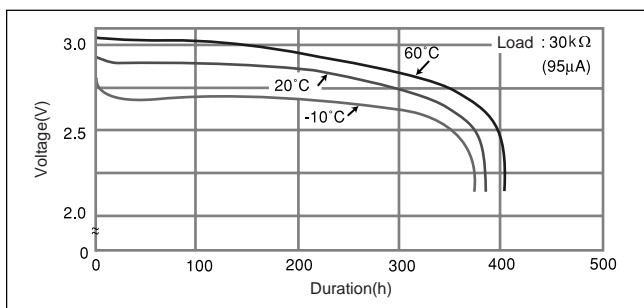

### ■ Operating voltage vs. load resistance (voltage at 50% discharge depth)

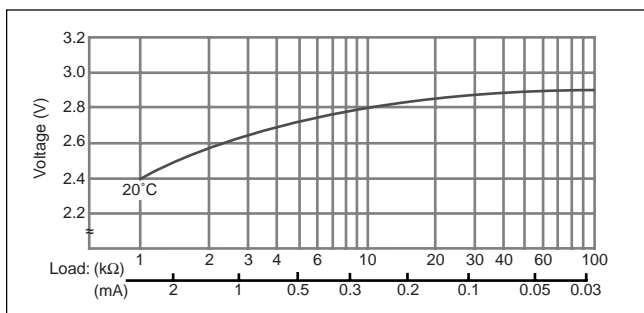

### ■ Capacity vs. load resistance

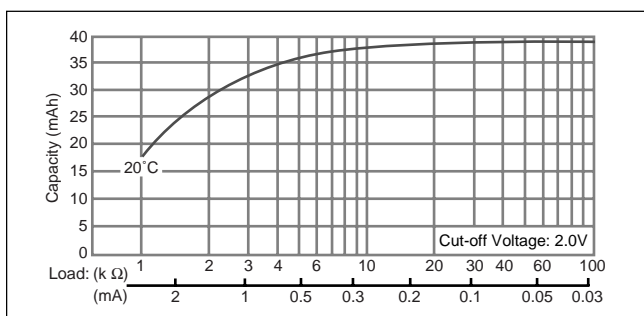

## CR1612

### ■ Dimensions(mm)

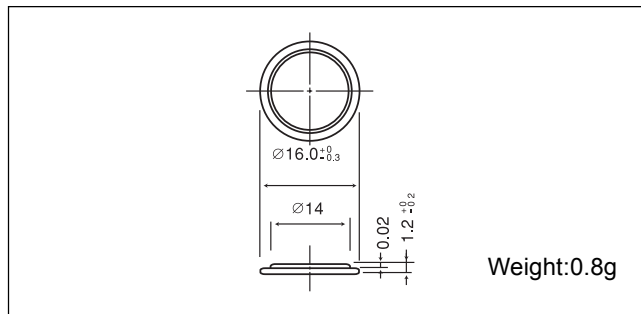

### ■ Specification

Nominal voltage (V)	3
Nominal capacity (mAh)	40
Continuous standard load (mA)	0.1
Operating temperature (C)	-30 ~ +60

### ■ Temperature Characteristics

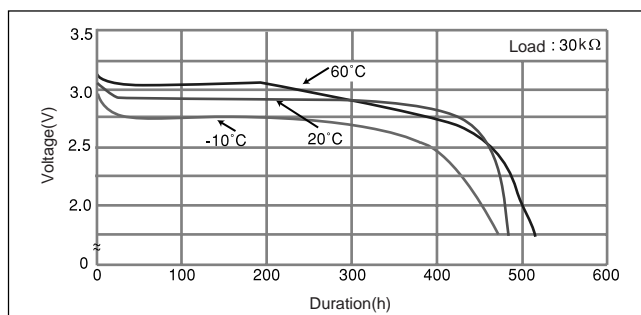

### ■ Operating voltage vs. load resistance (voltage at 50% discharge depth)

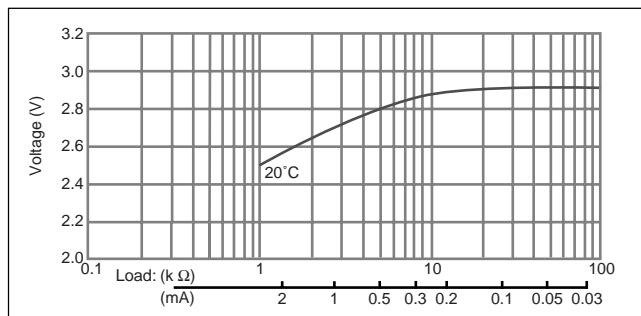

### ■ Capacity vs. load resistance

