

Manganese Dioxide Lithium Cylindrical Batteries: Individual Specifications

CR2

■ Dimensions(mm)

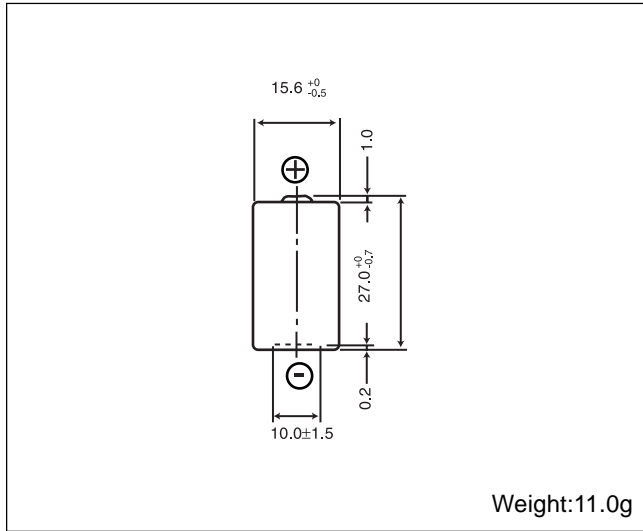

■ Specification

Nominal voltage (V)	3
Nominal capacity (mAh)	850
Continuous standard load (mA)	20
Operating temperature (C)	-40 ~ +70*

* Please consult Panasonic for use below and above -20°C to +60°C

■ Temperature Characteristics

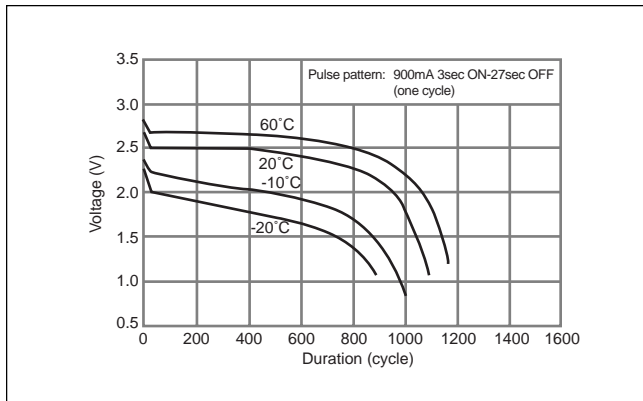

* Please consult Panasonic for use below and above -20°C to +60°C

CR123A

■ Dimensions(mm)

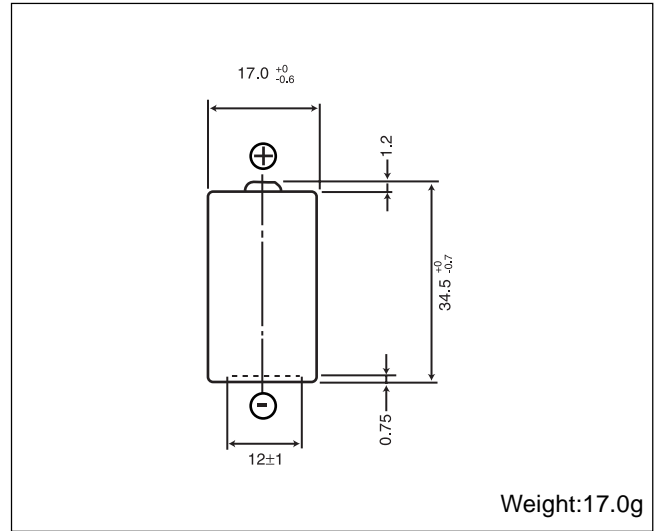

■ Specification

Nominal voltage (V)	3
Nominal capacity (mAh)	1,400
Continuous standard load (mA)	20
Operating temperature (C)	-40 ~ +70*

■ Temperature Characteristics

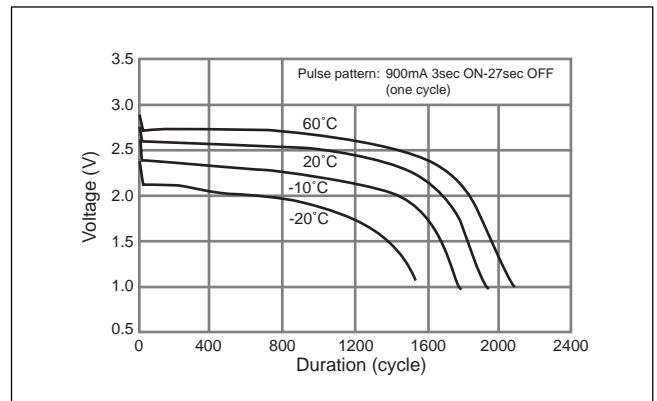

* Please consult Panasonic for use below and above -20°C to +60°C